

# LUX ELEMENTS®-RELAX-RP ...

Instructions for assembly · Instructions de montage · Instrucciones de montaje

Made in Germany

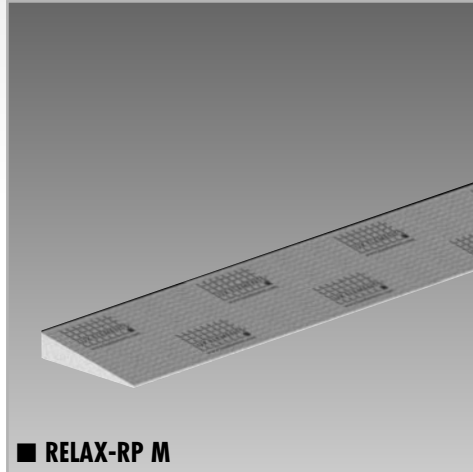

■ RELAX-RP M

203 x 1828 x 45/6 mm · 8" x 6' x 1 49/64" to 0 15/64"

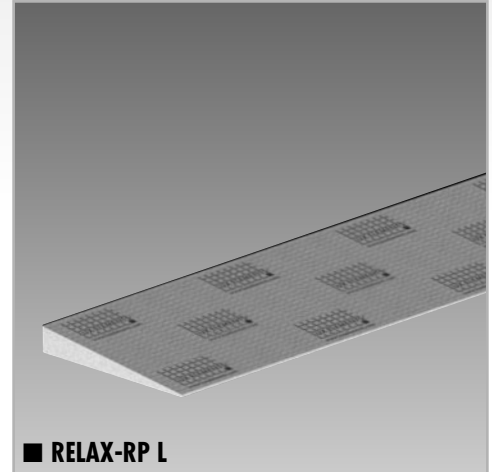

■ RELAX-RP L

304 x 1828 x 45/6 mm · 11" x 6' x 1 49/64" to 0 15/64"



## TOOLS/MATERIALS REQUIRED

## OUTILS/MATERIAUX REQUIS · HERRAMIENTAS/MATERIALES NECESARIOS

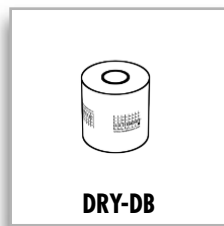
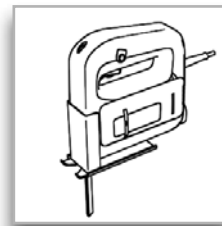
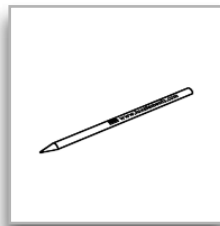
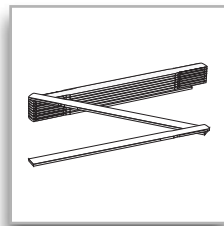

DRY-DB



[A]

DRY-ASK

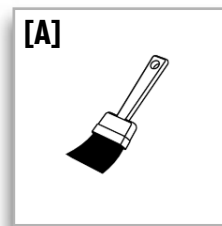

[A]

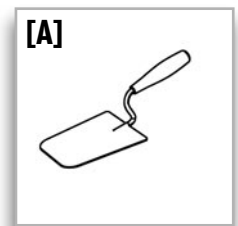

[A]

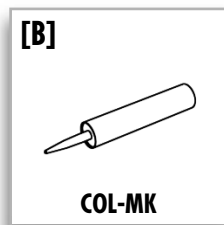

[B]

COL-MK

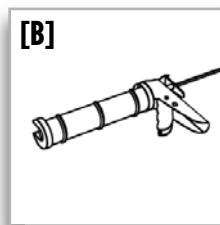

[B]

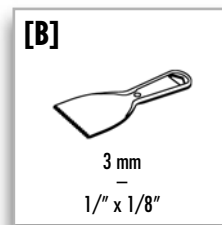

[B]

3 mm  
—  
1/8" x 1/8"

[A] / [B]

[EN] – Explanation:  
... see rear side

[FR] – Explication :  
... voir au verso

[ES] – Explicación:  
... véase al revés

08/2016 We reserve the right to make technical changes  
Sous réserve de modifications techniques  
Bajo reserva de modificaciones técnicas



[EN] – For further information ...  
please refer to our documents. Data sheets, test certificates and processing instructions can be downloaded from [www.luxelements.com](http://www.luxelements.com)

[FR] – Pour de plus amples informations ...  
veuillez consulter nos documents. Les fiches techniques, certificats de contrôle et instructions de mise en œuvre peuvent être téléchargés sur [www.luxelements.com](http://www.luxelements.com)

[ES] – Para obtener más informaciones ...  
consulte nuestros documentos. Las fichas técnicas, certificaciones y las instrucciones de proceso pueden ser descargadas en [www.luxelements.com](http://www.luxelements.com)

# LUX ELEMENTS®-RELAX-RP ...

Instructions for assembly · Instructions de montage · Instrucciones de montaje

Made in Germany

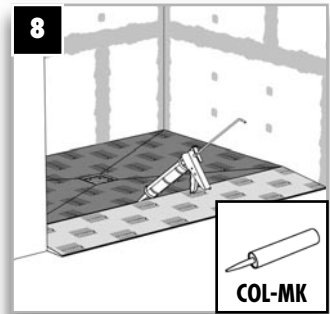
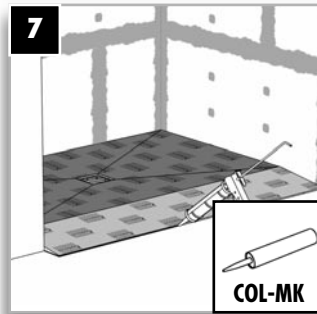
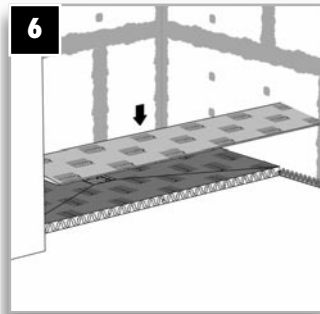
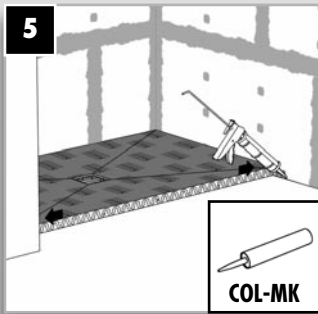
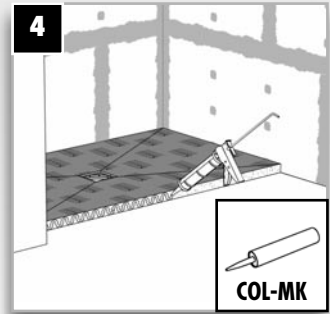
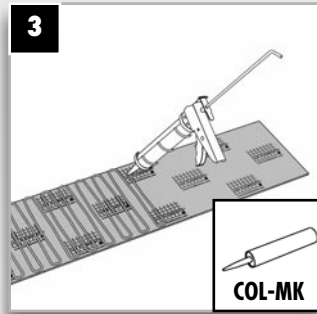
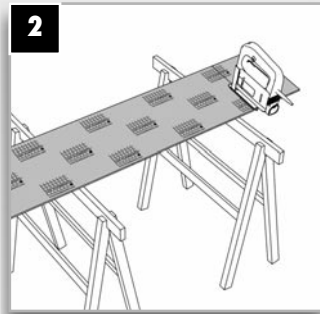
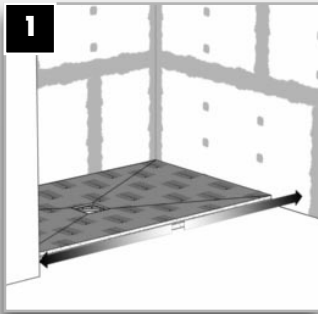

**[EN] – PLEASE OBSERVE ...**

- Sealing with LUX ELEMENTS®-DRY-ASK = VARIANTE 'A', steps 9.A – 11.A
- Sealing with LUX ELEMENTS®-COL-MK = VARIANTE 'B', steps 9.B – 12.B

**[FR] – VEUILLEZ TENIR COMPTE ...**

- Etanchéifier avec LUX ELEMENTS®-DRY-ASK = VARIANTE 'A', Etapes 9.A – 11.A
- Etanchéifier avec LUX ELEMENTS®-COL-MK = VARIANTE 'B', Etapes 9.B – 12.B

**[ES] – ATENCIÓN ...**

- Sellar con LUX ELEMENTS®-DRY-ASK = VARIANTE 'A', pasos 9.A – 11.A
- Sellar con LUX ELEMENTS®-COL-MK = VARIANTE 'B', pasos 9.B – 12.B

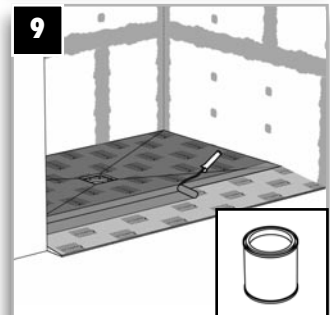
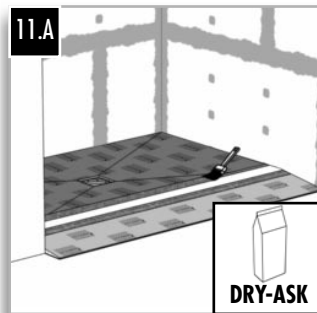
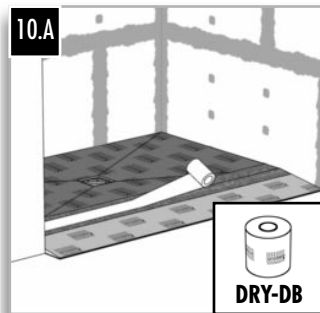
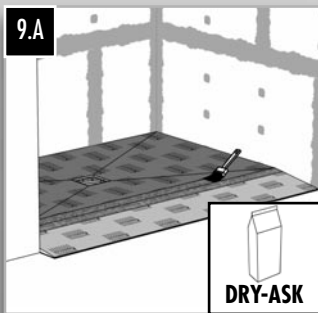

Sealing filler · Colle d'étanchéité  
Mortero de impermeabilización

**[EN] – Sealing with liquid sealants: only with prior approval of the respective manufacturer!**

**[FR] – Etanchéifier avec une étanchéité liquide: seulement après consultation et accord du fabricant !**

**[ES] – Sellar con sellados líquidos: solo con previa autorización del fabricante en cuestión!**

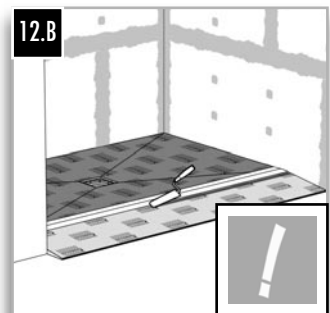
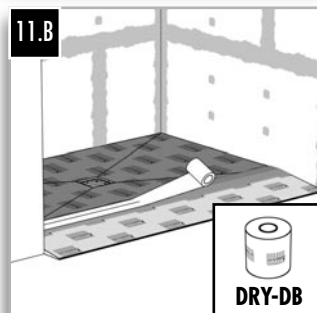
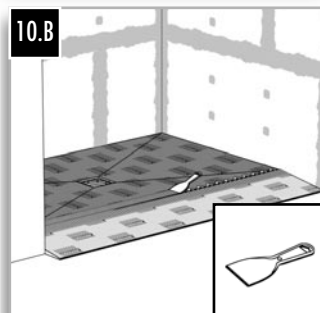
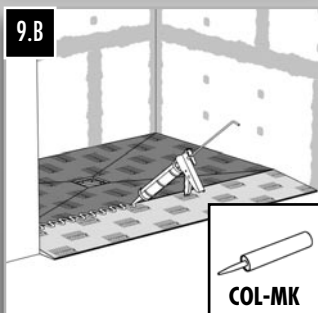

3 mm · 1/8" x 1/8"

Remove excess adhesive  
Niveler et retirer l'excédent de colle  
Eliminar el adhesivo sobresaliente

We reserve the right to make technical changes  
Sous réserve de modifications techniques  
Bajo reserva de modificaciones técnicas  
08/2016 · PROS5156



Welcome to ... · Bienvenue chez ...

LUX ELEMENTS – The original can do · L'original : La solution

Solutions for modern building design · Solutions pour des constructions modernes